



Applicable Socket:
SO-1064-003

Application Notes:
001
002
103B
007

- Magnetic latch operation
- All weld construction

• Contact arrangement 2 PDT

• Qualified to MIL-PRF-6106

PRINCIPLE TECHNICAL CHARACTERISTICS

• Contacts rated at Low level, 28 Vdc and 115/200 Vac, 400Hz, 3Ø, case grounded

• Weight 0.036 lbs. max

• Dimensions 0.41in x 0.81in x 0.64in

• Special models available upon request

• Hermetically sealed, corrosion resistant can

CONTACT ELECTRICAL CHARACTERISTICS

Contact rating per pole and load type [1]	Load current in Amps		
	28 Vdc	115 Vac, 400 Hz, 1Ø	115/200 Vac, 400 Hz, 3Ø
Resistive	5	5	5
Inductive [2]	3	5	5
Motor	2	3	3
Lamp	1	1	-
Overload	20	30	30
Rupture	25	40	40
Low level [3]	-	-	-
Time current characteristics [4]	-	-	-

COIL CHARACTERISTICS (Vdc)

CODE	A	B	C	N [5]	R [5]	V [5]
Nominal operating voltage	28	12	6	28	12	6
Maximum operating voltage @125°C	29	14.5	7.3	29	14.5	7.3
Maximum pickup voltage						
- Cold coil at +125° C	18	9	4.5	18	9	4.5
- During high temp test at +125° C	19.8	9.9	5	19.8	9.9	5
- During continuous current test at +125° C	22.5	11.25	5.7	22.5	11.25	5.7
Coil resistance in Ω $\pm 10\%$ at +25° C except types "C" and "R" +20%, - 10%	730	182	43	730	182	43

GENERAL CHARACTERISTICS

Temperature range	-70°C to +125°C [7]
Minimum operating cycles (life) at rated load	100,000 [2]
Minimum operating cycles (life) at 25% rated load	400,000
Dielectric strength at sea level	
- All circuits to ground and circuit to circuit	1000 Vrms
- Coil to ground and coil to coil	500 Vrms
Dielectric strength at altitude 80,000 ft	500 Vrms [6]
Insulation resistance	
- Initial (500 Vdc)	100 M Ω min
- After environmental tests (500 Vdc)	50 M Ω min
Sinusoidal vibration (A, D and J mounting)	0.12 d.a. / 10 to 70 Hz 30G / 70 to 3000 Hz
Sinusoidal vibration (G mounting)	0.12 d.a. / 10 to 57 Hz 20G / 57 to 3000 Hz
Random vibration	
- Applicable specification	MIL-STD-202
- Method	214
- Test condition - A, D and J mounting	1G (0.4G ² /Hz, 50 to 2000 Hz)
- Test condition - G mounting	1E (0.2G ² /Hz, 50 to 2000 Hz)
- Duration	15 minutes each plane
Shock (A, D and J mounting)	200G / 6 ms
Shock (G mounting)	100G / 6 ms
Maximum contact opening time under vibration and shock	10 μ s
Operate time at nominal voltage@25°C	4 ms max
Release time at nominal voltage@25°C	4 ms max
Contact make bounce at nominal voltage@25°C	1.0 ms max
Weight maximum	0.036 lbs.

Unless otherwise noted, the specified temperature range applies to all relay characteristics.

Dimensions in inches
Tolerances, unless otherwise specified, ± 0.03 in

MOUNTING STYLES

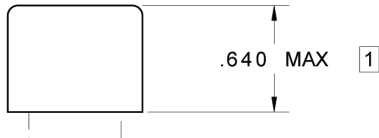

MOUNTING STYLE A

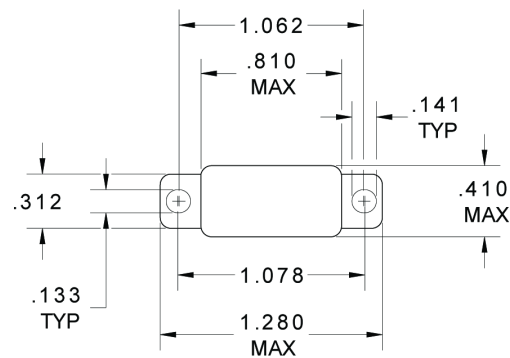
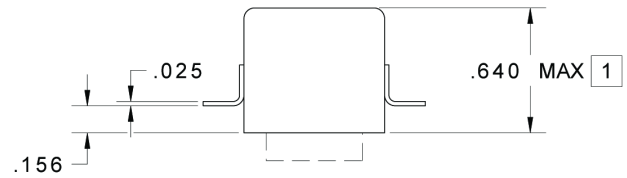

MOUNTING STYLE D

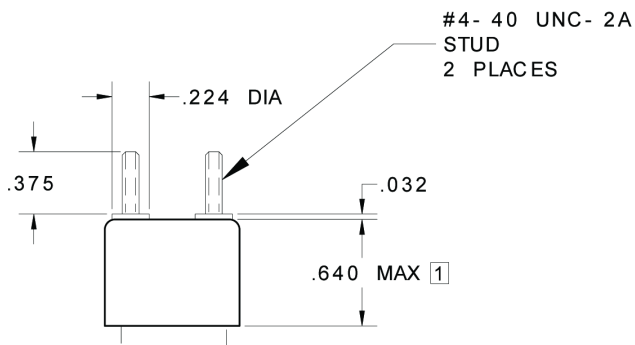
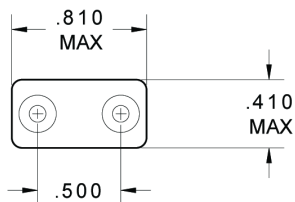

MOUNTING STYLE G

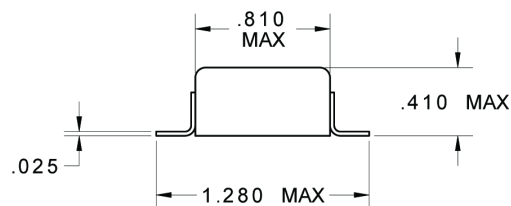
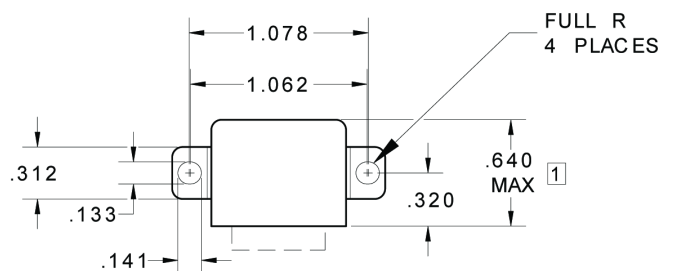

MOUNTING STYLE J

1 RELAY HEIGHT MAY BE INCREASED .100 INCH FOR "N" SUPPRESSED COILS

Dimensions in inches
Tolerances, unless otherwise specified, ± 0.03 in

TERMINAL TYPES

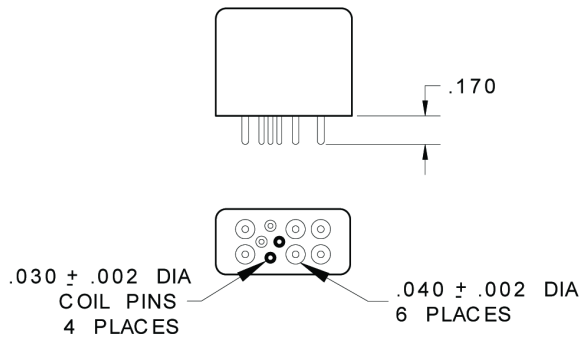

TERMINAL TYPE 1

FINISH:
BODY - TIN/ LEAD
TERMINALS - TIN/ LEAD

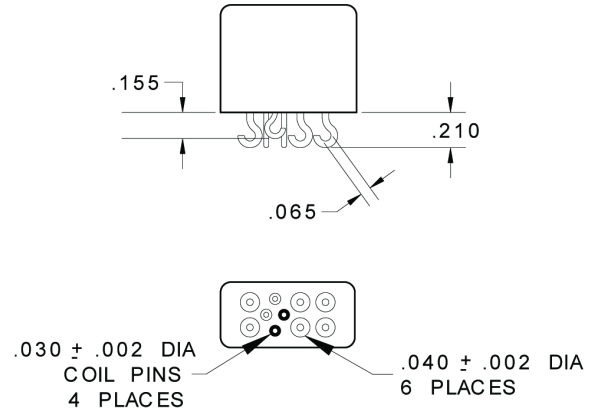

TERMINAL TYPE 2

FINISH:
BODY - TIN/ LEAD
TERMINALS - TIN/ LEAD

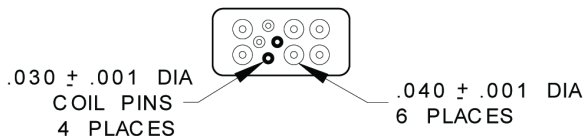
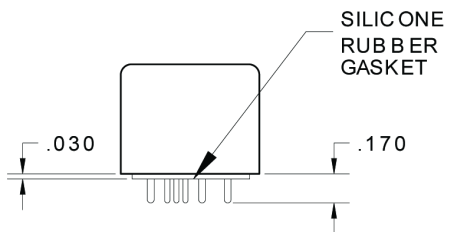

TERMINAL TYPE 4

FINISH:
BODY - TIN/ LEAD
TERMINALS - GOLDPLATED

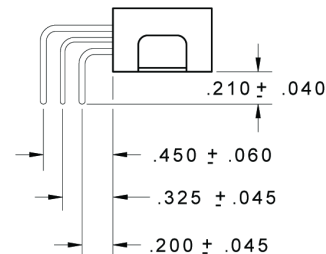
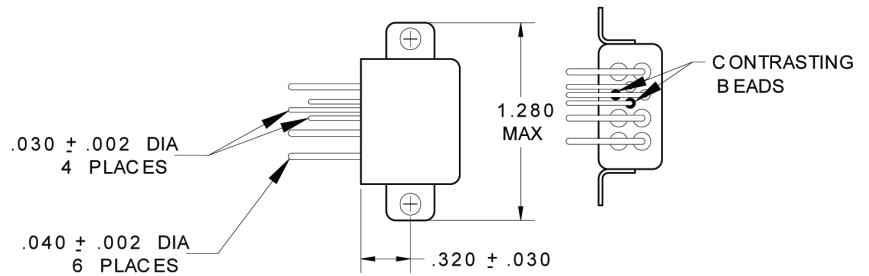

TERMINAL TYPE 7

FINISH:
BODY - TIN/ LEAD
TERMINALS - TIN/ LEAD

Dimensions in inches
Tolerances, unless otherwise specified, ± 0.03 in

DIAGRAMS

SCHEMATIC DIAGRAM

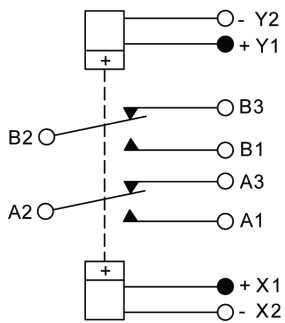

WIRING DIAGRAM

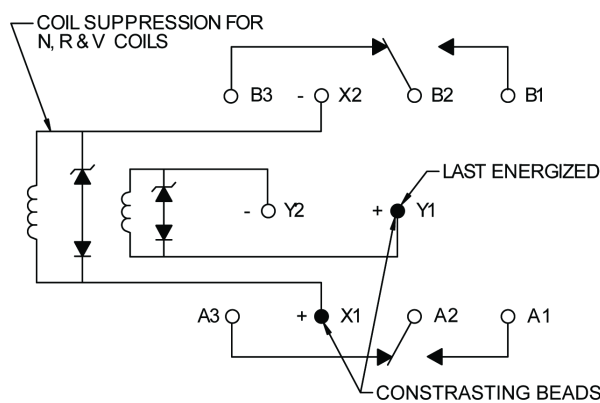

STANDARD TERMINAL LAYOUT

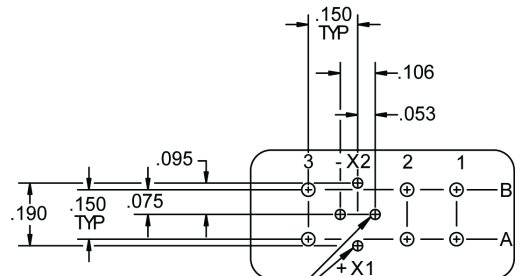

CONSTRAINING BEAD
POLARIZING PIN FOR
TERMINAL TYPE 4 ONLY

TOL: .XX ±.03; .XXX ±.010

NUMBERING SYSTEM

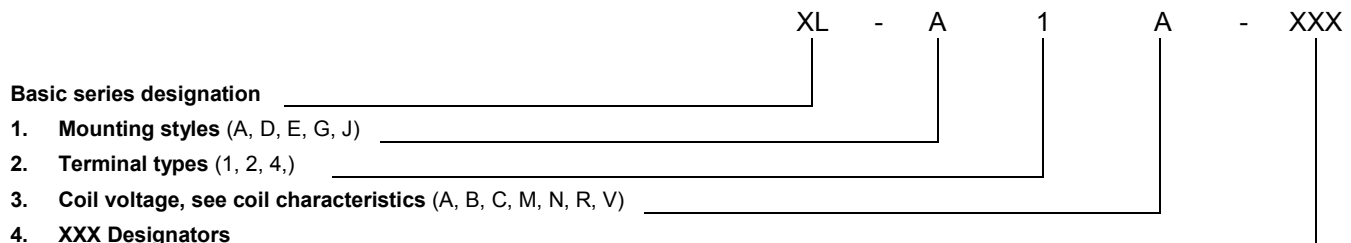

NOTES

1. Standard Intermediate Current test applicable; relay can also switch low level loads while switching any of the other rated loads on adjacent contacts.
2. Inductive load life: 20,000 cycles.
3. Low level endurance test: contact load of 10 to 50 millivolt, 10 to 50 microamp, 100 Ohm max. contact resistance.
4. Refer to MIL-PRF-6106 for details.
5. "N" "R" & "V" coils have back EMF suppression to 42 volts maximum.
6. 500 Vrms with silicone rubber gasket compressed, 250 Vrms all other conditions.
7. "N", "R" & "V" coils derated to 85° C.
8. Reference MIL-PRF-6106/38
9. Relay will not be damaged, but may transfer with application of reverse polarity to coil.

For any inquiries, please contact your local sales representative: leachcorp.com